



Sutopo, M.T.
Pendidikan Teknik Mesin
Fakultas Teknik – UNY
Maret 2012



CAIRAN PEMOTONGAN DAN APLIKASINYA

Cairan Pemotongan

- Sangat penting dalam proses pemesinan (metal-cutting operations) untuk menurunkan panas dan gesekan
- Soluble oils ada 1936
- Chemical cutting fluids diperkenalkan 1944

Keuntungan ekonomis dlm penggunaan cutting fluid

- Menurunkan tool cost
 - Menurunkan keausan tool dan umur tools lebih lama
- Meningkatkan kecepatan produksi
 - Menurunkan panas dan gesekan sehingga cutting speeds dpt lebih tinggi
- Menurunkan upah pegawai (labor cost)
 - Umur tool yang lama, menurunkan waktu *regrinding*, mengurangi *downtime*, menurunkan ongkos per komponen
- Menurunkan pemakaian daya (power costs)
 - Gesekan yang menurun, mengurangi penggunaan daya pemesian

Pembentukan panas dlm machining

- Panas terbentuk akan dilepas melalui:
 - Bendakerja, tool and tatal (chips)

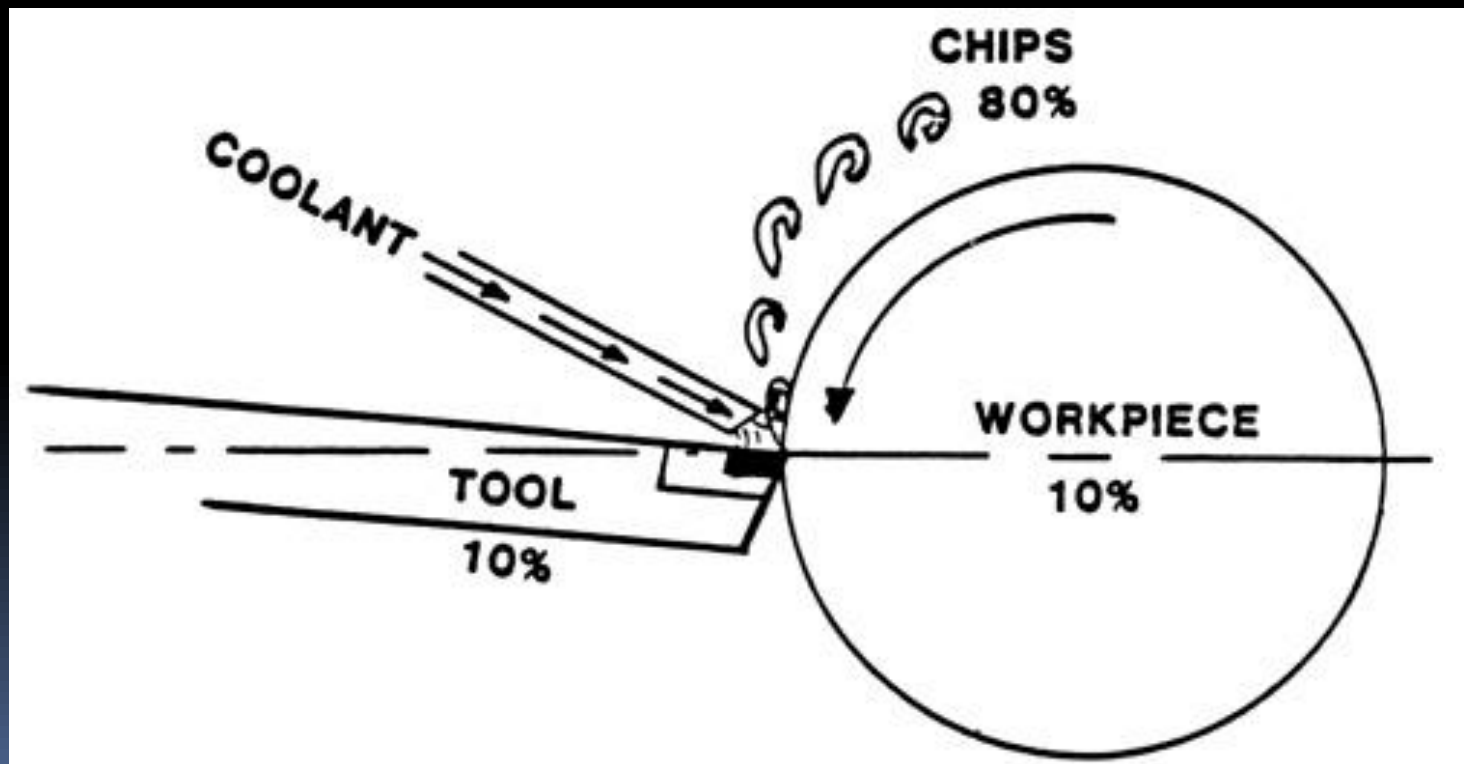

Pelepasan panas

- Idealnya sebagian besar diambil oleh tatal
- Indikasinya ada perubahan warna tatal yang disebabkan oksidasi
- *Cutting Fluid* menyerap panas yang terbentuk
 - Dapat menyerap 50% panas yang terbentuk

Karakteristik Cutting Fluid yg baik

1. Kemampuan pendinginan baik
2. Kualitas pelumasan baik
3. Tahan untuk tdk berbau
4. Viskositas relatif rendah
5. Stabilitas tinggi (long life)
6. Tahan korosi
7. Tak beracun
8. Transparan
9. Tidak terbakar



Type-type Cutting Fluids

- Terbagi dalam 3 kategori
 - Cutting oils
 - Emulsifiable oils
 - Chemical (synthetic) cutting fluids
- 

Cutting Oils

- Klasifikasi ada 2:
 - Active
 - Inactive
- oil's terkait dengan aktivitas kimia atau kemampuan untuk melindungi logam karena:
 - Kenaikan suhu (Elevated temperatures)
 - Meningkatkan aksi pemotongan (Improve cutting action)
 - Melindung Protect surface

Active Cutting Oils

- Those that will darken copper strip immersed for 3 hours at temperature of 212°F
- Gelap atau transparan (Dark or transparent)
- Baik untuk kerja berat (Better for heavy-duty jobs)
- Ada 3 kategori
 - Sulfurized mineral oils
 - Sulfochlorinated mineral oils
 - Sulfochlorinated fatty oil blends

Inactive Cutting Oils

- Kandungan sulfurnya alami
 - Dinamakan inactive sebab sulfur telah tercampur sempurna dalam oil
- Kategorinya ada 4:
 - Straight mineral oils, fatty oils, fatty and mineral oil blends, sulfurized fatty-mineral oil blend

Emulsifiable (Water Soluble) Oils

- Mineral oils memiliki kandungan unsur seperti sabun yang membuatnya larut dlm air dan melekat pada benda kerja
- Emulsifiers (mempercepat reaksi) dan menjaga partikel terpisah dari air
 - 1:10 atau 1:20
- Kualitas pendinginan dan pelumasan baik
- Digunakan pada high cutting speeds, low cutting pressures

Chemical Cutting Fluids

- Disebut juga synthetic fluids
- Stabil, preformed emulsions
 - Terdiri dari sedikit oil dan mudah dicampur air
- Ada Penambahan pelumas yang bersifat Extreme-pressure (EP)
- Menurunkan panas karena gesekan dan panas karena deformasi plastis (plastic deformation of metal)

Keuntungan Synthetic Fluids

1. Ketahanan korosi bagus
2. Tahan untuk tak berbau dlm waktu lama
3. Mereduksi/menurunkan panas selama proses pemotongan
4. Kualitas pendinginan 'Excellent'

- 
5. Umur pakai lebih lama dari soluble oil
 6. Tak terbakar-tak berasap (Nonflammable – nonsmoking)
 7. Nontoxic??????
 8. Mudah dipisahkan dari benda kerja dan chip
 9. Tak ada sumbatan (No clogging of machine cooling system)
 10. Can leave a residue on parts and tools

Perhatian!!! (Caution)

- Chemical cutting fluids telah digunakan secara luas untuk logam ferro (ferrous metals). Tidak direkomendasikan untuk penggunaan pada paduan magnesium, zinc, cadmium, atau lead. Karena akan mengotori permukaan hasil pemotongan

Table 5.2 Guide to the Selection of Water-Miscible Cutting Fluids^a

Machining operation	Workpiece material							
	Free-machining nonferrous alloys	Tough nonferrous alloys	Free-machining and low-carbon steels	Medium-carbon steels	High-carbon and alloy steels			
Grinding	General-purpose or clear-type, soluble oils		Clear-type, soluble oil or chemical grinding fluid					
Turning	General-purpose, soluble oil	General-purpose or fatty, soluble oils	General-purpose, soluble oil or synthetic fluid		Extreme pressure or synthetic fluid			
Milling			General-purpose or fatty, soluble oils		Extreme-pressure, soluble oil or synthetic fluid	Extreme-pressure synthetic fluid may be used		
Drilling	General-purpose or fatty, soluble oils		Fatty or extreme-pressure, soluble oils; synthetic fluids	Extreme-pressure, soluble oil or synthetic fluid			Extreme-pressure synthetic fluid may be used	
Gear shaping			Extreme-pressure, soluble oil or synthetic fluid		Neat cutting oil			
Hobbing			Extreme-pressure, soluble oil or synthetic fluid			Neat cutting oil		
Broaching			Extreme-pressure soluble oil or synthetic fluid					
Tapping	General-purpose or fatty, soluble oils (neat cutting oils may be preferable)		Extreme-pressure, soluble oil or synthetic fluid (neat cutting oils may be preferable)		Neat cutting oil			

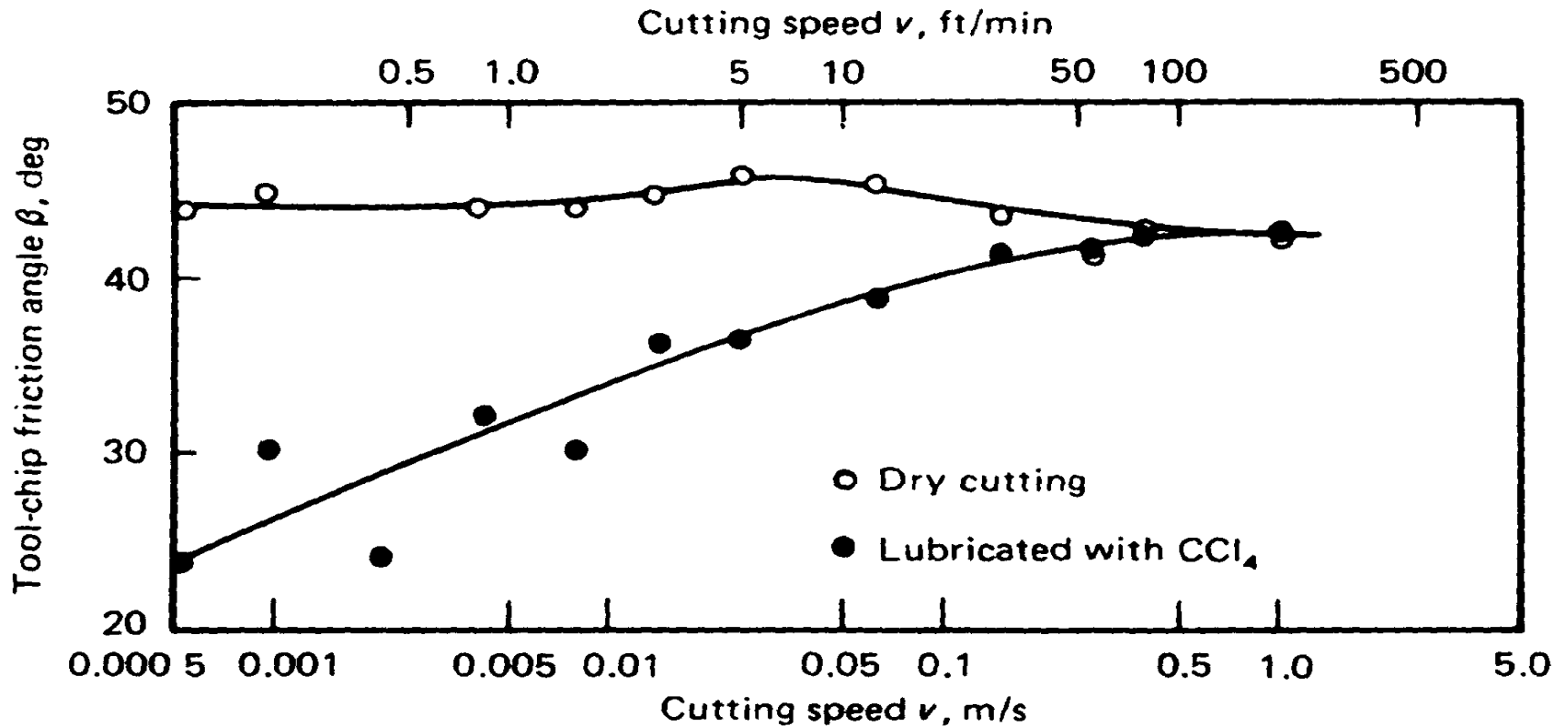

Figure 5.2 The effect of cutting speed on the lubricating action of carbon tetrachloride, where the work material is copper, the undeformed chip thickness is 0.25 mm (0.01 in.), the chip-tool contact length is 0.3 mm (0.012 in.), and the tool rake is 45 deg. (After Cassin and Boothroyd [3].)

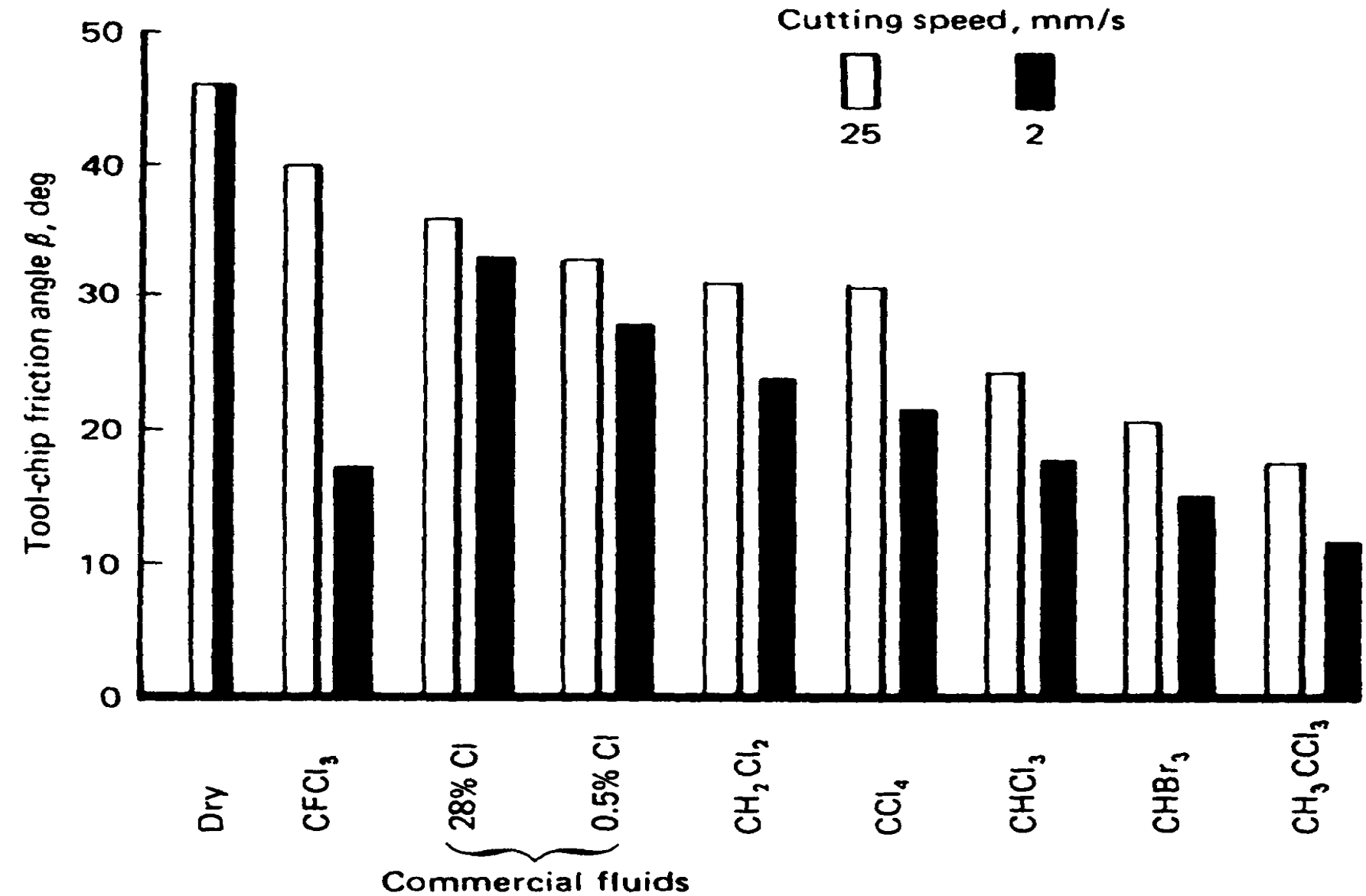

Figure 5.3 The lubricating action of various fluids, where the work material is copper, the undeformed chip thickness is 0.25 mm (0.01 in.), and the tool rake is 45 deg. (All fluids are applied liberally.) (After Cassin and Boothroyd [3].)

Table 5.3 Characteristics of Neat Cutting Oils^a

Oil no.	Description	Viscosity ($\mu\text{m}^2/\text{s}$ at 38°C)
1	Very-low-viscosity, inactive oil containing fatty and chlorinated additives	5.5
2	Inactive oil containing sulfurized fatty extreme-pressure additive	22.5
3	Inactive oil similar to No. 2 but with higher additive content	19.7
4	Multipurpose, chlorinated extreme-pressure oil with anti-stick-slip additives	37.8
5	Active oil containing free sulfur and sulfurized fat	25.0
6	Similar to No. 5 but with higher additive content	19.7
7	Inactive, extreme-pressure oil containing chlorinated and fatty additives; light in color	40.2
8	Low-viscosity, active oil containing free sulfur and sulfurized fatty additives	12.5
9	Special-purpose, highly chlorinated, active extreme-pressure oil	12.5

Table 5.4 Guide to the Selection of Neat Cutting Oils^{a,b}

Machining operation	Workpiece material					
	Free-machining, nonferrous alloys	Tough, nonferrous alloys	Free machining and low-carbon steels	Medium-carbon steels	High-carbon and alloy steels	Stainless and heat-resistant alloys
Thread or form grinding	2	3	5	6 or 7		7
Turning	2 or 4	3 or 4		3, 4, or 5	6 or 4	6 or 7
Milling				4 or 5	6 or 7	
Drilling				5 or 6	6 or 8	8 or 9
Gear shaping				5 or 6		7 or 8
Hobbing	3		3 or 5	6 or 8		7 or 9
Broaching	3 or 4		6	8 or 9	9	
Tapping	2	2 or 3		6 or 8	8 or 9	

^aThe numbers refer to the oils listed in Table 5.3.

^bAfter Holmes [1].

Fungsi-fungsi Cutting Fluid

- Fungsi utama;
 - Memberikan pendinginan
 - Memberikan pelumasan
- Fungsi lain:
 - Memperpanjang cutting-tool life
 - Perlindungan pada korosi

Fungsi Cutting Fluid sebagai pendingin

- Panas memiliki pengaruh pada keausan tool
 - Sedikit penurunan panas akan berdampak besar terhadap umur tool
- Dua (2) sumber panas dlm pemesian logam
 - Deformasi plastis dari logam
 - Terjadi seketika di ujung alat potong
 - Menyumbang sekitar 75 % panas
 - Gesekan total dengan permukaan tool

Fungsi Cutting Fluid sebagai pendingin

- Air adalah pendingin yang paling efektif dalam menurunkan panas tetapi menyebabkan *rust* (korosi akibat oksidasi)
- Penurunan panas pada bidang kontak tatal-tool (chip-tool interface) 50 degrees F, meningkatkan umur pahat 5 kali lipat

Fungsi Cutting Fluid sebagai pelumas (Lubrication)

- Menurunkan gesekan antara chip dan tool face
 - Bidang geser menjadi lebih pendek
 - Area dimana plastic deformation terjadi cenderung mengecil
- Cairan pemotongan dgn Extreme-pressure (EP) lubricants menurunkan panas yang terbentuk karena gesekan
- Kandungan kimia EP dari synthetic fluids berpadu dgn unsur2 kimiawi mempercepat chip meninggalkan area pemotongan

Cutting fluid menurunkan gesekan dan menghasilkan bidang geser yang lebih pendek

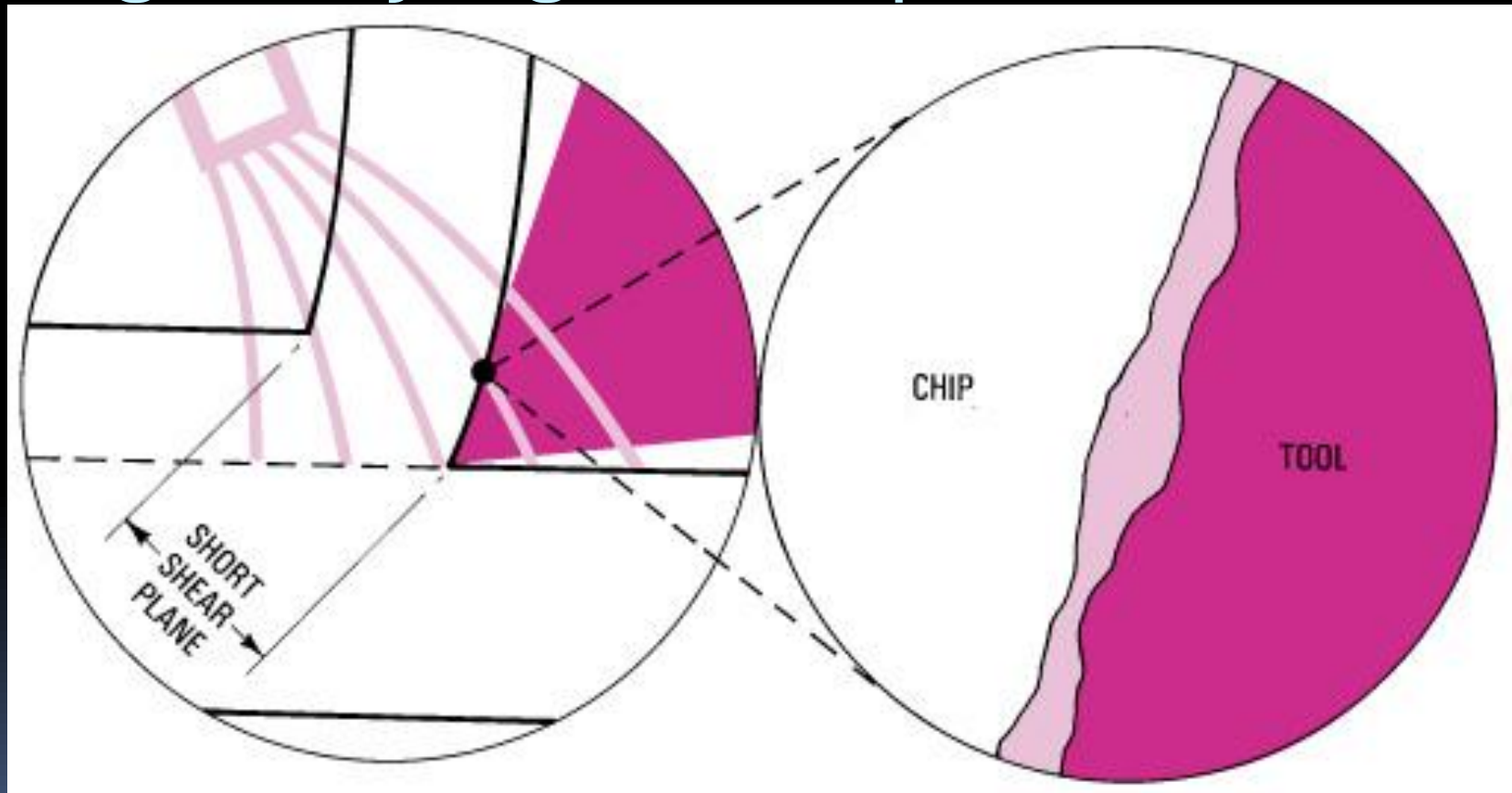

Cutting fluid reduces friction and produces a shorter shear plane.

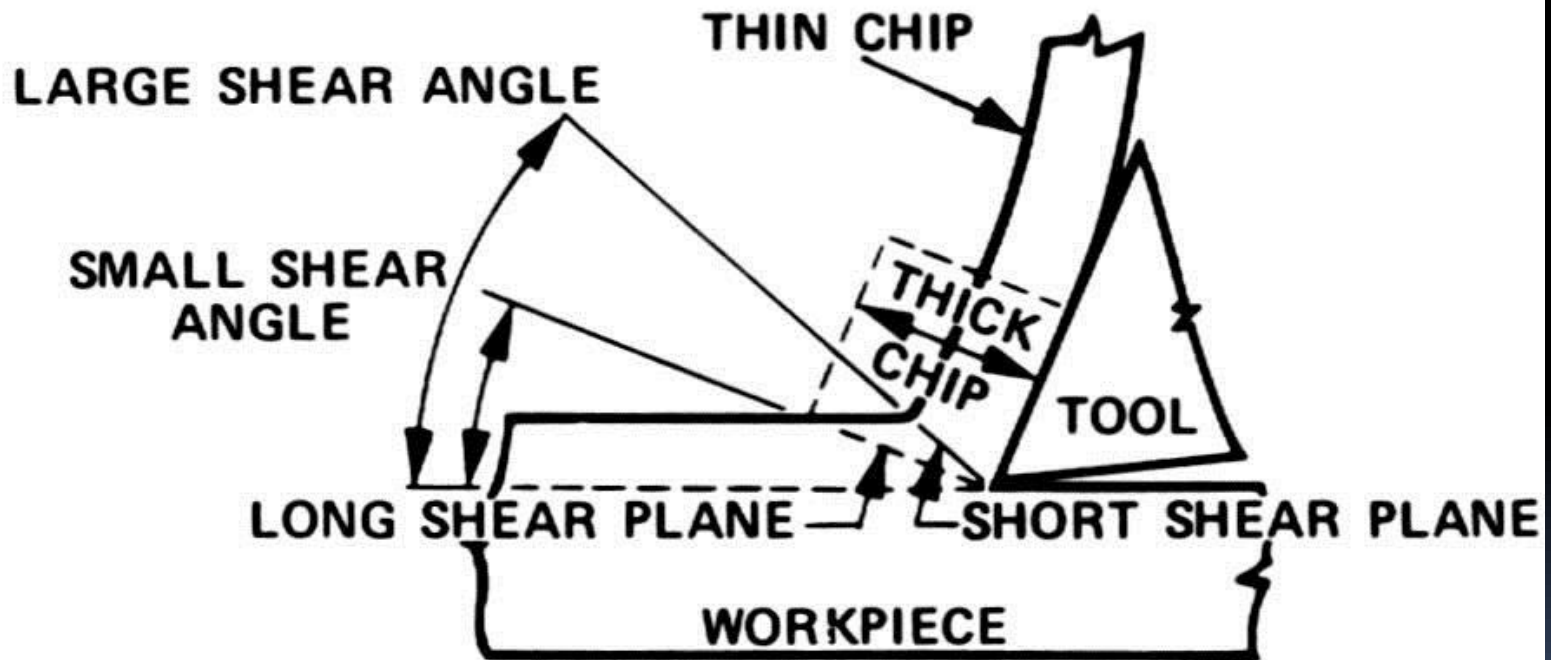

Cutting-Tool Life

- Heat and friction prime causes of cutting-tool breakdown
- Reduce temperature by as little as 50°F , life of cutting tool increases fivefold
- Built-up edge
 - Pieces of metal weld themselves to tool face
 - Becomes large and flat along tool face, effective rake angle of cutting tool decreased

Built-up Edge

Built-up edge keeps
breaking off and
re-forming

Result is poor
surface finish,
excessive flank
wear, and cratering
of tool face

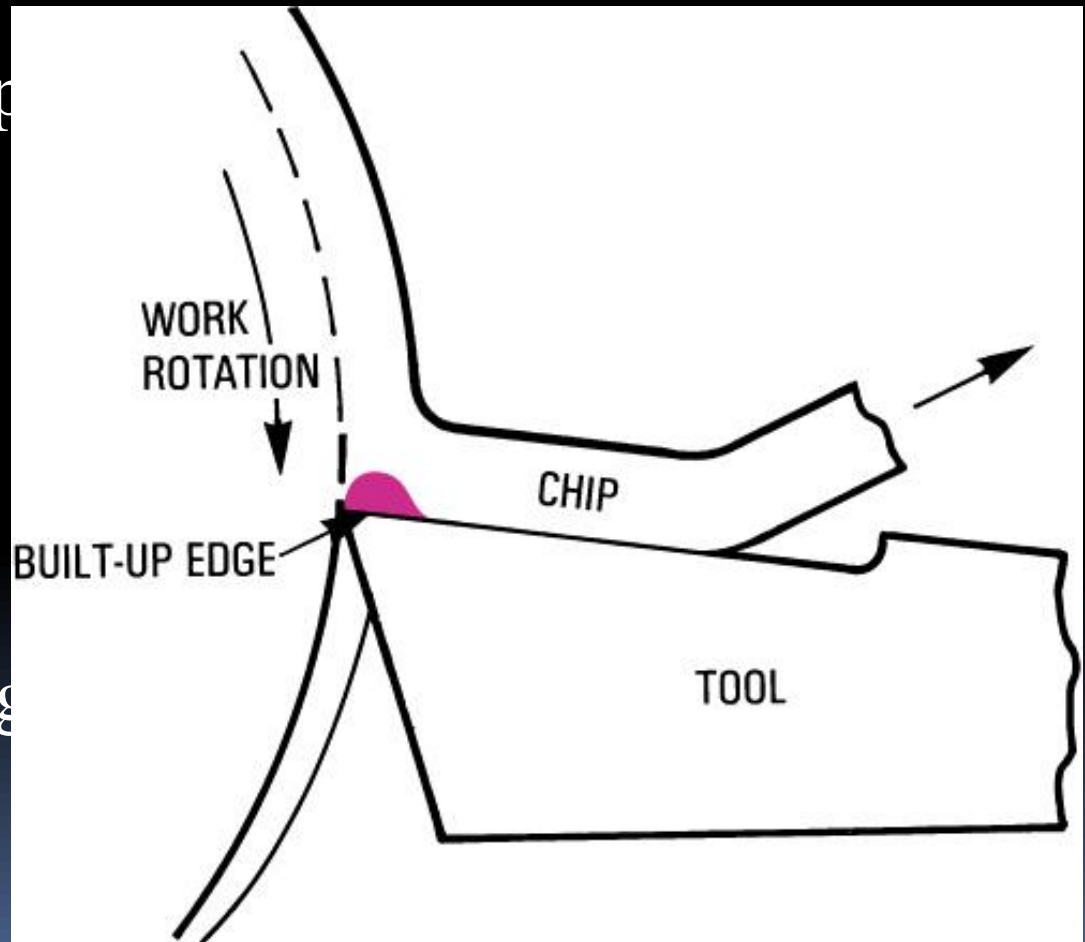

Cutting Fluid's Effect on Cutting Tool Action

1. Lowers heat created by plastic deformation of metal
2. Friction at chip-tool interface decreased
3. Less power is required for machining because of reduced friction
4. Prevents built-up edge from forming
5. Surface finish of work greatly improved



Rust Control

- Water best and most economical coolant
 - Causes parts to rust
- Rust is oxidized iron
- Chemical cutting fluids contain rust inhibitors
 - Polar film
 - Passivating film

Application of Cutting Fluids

- Cutting-tool life and machining operations influenced by way cutting fluid applied
- Copious stream under low pressure so work and tool well covered
 - Inside diameter of supply nozzle $\frac{3}{4}$ width of cutting tool
 - Applied to where chip being formed